



POWER SUPPLY

- AC 200-240V Input
- Efficiency up to 94.5%
- Width only 70mm
- 150% Peak Load Capability
- Full Power Between -25°C and +60°C
- DC-OK Relay Contact
- Quick-connect Spring-clamp Terminals
- 3 Year Warranty

1. GENERAL DESCRIPTION

The most outstanding features of this Dimension Q-Series power supply are the high efficiency and the small size, which are achieved by a synchronous rectification and further novel design details.

The QS20.244 is a device for 200-240V non-public mains only. This supports regional applications and offers additional cost and space savings.

With short-term power capability of 150% and built-in large sized output capacitors, these features help start motors, charge capacitors and absorb reverse energy. Diagnostics are easy due to the DC-ok relay, a green DC-ok and a red overload LED.

Unique quick-connect spring-clamp terminals allow a safe and fast installation. Many global approvals make this unit suitable for nearly every situation.

QS20-Series

Related products

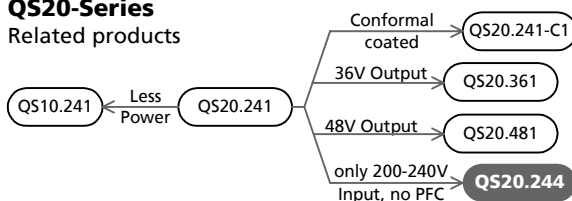

2. SHORT-FORM DATA

Output voltage	DC 24V	
Adjustment range	24-28V	
Output current	20A	continuous, 24V
	30A	for typ. 4s, 24V
Output power	480W	continuous, 24V
	720W	for typ. 4s, 24V
Output ripple	< 100mVpp	20Hz to 20MHz
Input voltage	AC 200-240V	±15%
Mains frequency	50-60Hz	±6%
AC Input current	4.45A	at 230Vac
Power factor	0.5	at 230Vac
AC Inrush current	typ. 40A peak	at 230Vac
Efficiency	94.5%	at 230Vac
Losses	28.3W	at 230Vac
Temperature range	-25°C to +70°C	operational
Derating	12W/°C	+60 to +70°C
Hold-up time	typ. 46ms	at 230Vac
Dimensions	70x124x127mm	WxHxD

3. ORDER NUMBERS

Power Supply	QS20.244	24-28V unit
Accessory	ZM1.WALL	Wall mount bracket
	YR2.DIODE	Decoupling module

4. MARKINGS



INDEX PAGE

1. General Description	1
2. Short-form Data	1
3. Order Numbers	1
4. Markings	1
5. AC-Input	3
6. Input Inrush Current	4
7. Output	5
8. Hold-up Time	7
9. DC-OK Relay Contact	7
10. Efficiency and Power Losses	8
11. Functional Diagram	9
12. Front Side and User Elements	9
13. Terminals and Wiring	10
14. Reliability	10
15. EMC	11
16. Environment	12
17. Protection Features	13
18. Safety	13
19. Dielectric Strength	13
20. Approvals	14
21. Fulfilled Standards	14

INDEX PAGE



22. Used Substances	15
23. Physical Dimensions and Weight	15
24. Installation and Operation Instructions	16
25. Accessory	16
26. Application Notes	17
26.1. Repetitive Pulse Loading	17
26.2. Peak Current Capability	18
26.3. Back-feeding Loads	18
26.4. Charging of Batteries	18
26.5. Output Circuit Breakers	19
26.6. External Input Protection	20
26.7. Parallel Use to Increase Output Power ..	20
26.8. Parallel Use for Redundancy	20
26.9. Daisy-Chaining of Outputs	21
26.10. Series Operation	21
26.11. Inductive and Capacitive Loads	21
26.12. Operation on Two Phases	22
26.13. Use in a Tightly Sealed Enclosure	22
26.14. Mounting Orientations	23

INTENDED USE

The power supply shall only be installed and put into operation by qualified personnel.

This power supply is designed for installation in an enclosure and is intended for the general use, such as in industrial control, office, communication, and instrumentation equipment. Do not use this device in aircraft, trains and nuclear equipment, where malfunctioning of the power supply may cause severe personal injury or threaten human life.

TERMINOLOGY AND ABBREVIATIONS

PE and  symbol	PE is the abbreviation for Protective Earth and has the same meaning as the symbol  .
Earth, Ground	This document uses the term "earth" which is the same as the U.S. term "ground".
T.b.d.	To be defined, value or description will follow later.
AC 230V	A figure displayed with the AC or DC before the value represents a nominal voltage with standard tolerances (usually $\pm 20\%$) included. E.g.: DC 12V describes a 12V battery disregarding whether it is full (13.7V) or flat (10V) As long as not otherwise stated, AC 100V and AC 230V parameters are valid at 50Hz and AC 120V parameters are valid at 60Hz mains frequency.
230Vac	A figure with the unit (Vac) at the end is a momentary figure without any additional tolerances included.

DISCLAIMER

The information presented in this document is believed to be accurate and reliable and may change without notice.

Some parts of this unit are patent by PULS (US patent No 091662,063, Des. 424,529, ...).

No part of this document may be reproduced or utilized in any form without permission in writing from the publisher.

5. AC-INPUT

AC input	nom.	AC 200-240V	wide-range input, TN-, TT-, IT-Mains, see Fig. 5-1
AC input range	min.	170-276Vac	continuous operation
	min.	276-300Vac	< 500ms
Input frequency	nom.	50 – 60Hz	±6%
Turn-on voltage	typ.	155Vac	steady-state value, see Fig. 5-1
Shut-down voltage	typ.	110Vac	steady-state value, see Fig. 5-1

Input: 230Vac

Input current	typ.	4.45A	at 24V, 20A, see Fig. 5-3
Power factor *)	typ.	0.50	at 24V, 20A, see Fig. 5-4
Crest factor **)	typ.	4.2	at 24V, 20A
Start-up delay	typ.	140ms	see Fig. 5-2
Rise time	typ.	88ms	0mF, 24V, 20A, see Fig. 5-2
	typ.	95ms	20mF external capacitor, 24V, 20A, see Fig. 5-2
Turn-on overshoot	max.	50mV	see Fig. 5-2

*) The power factor is the ratio of the true (or real) power to the apparent power in an AC circuit.

**) The crest factor is the mathematical ratio of the peak value to RMS value of the input current waveform.

Fig. 5-1 **Input voltage range**

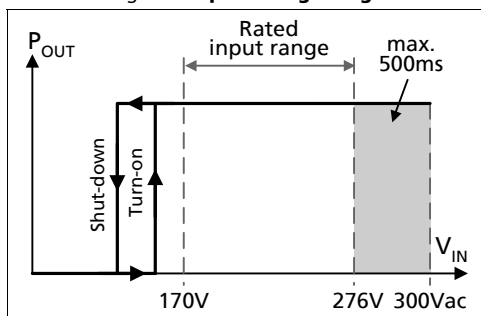

Fig. 5-2 **Turn-off behavior, definitions**

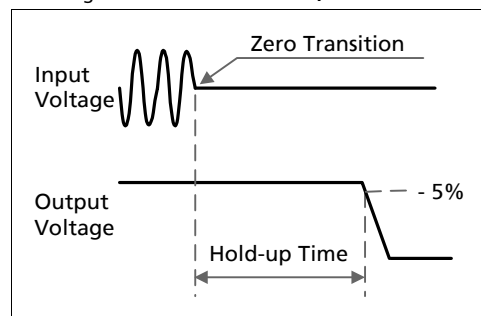

Fig. 5-3 **Input current (rms) vs. output load at 230Vac**

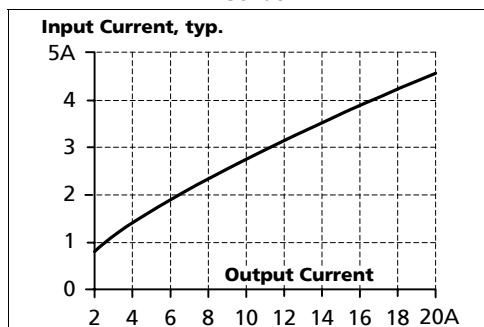
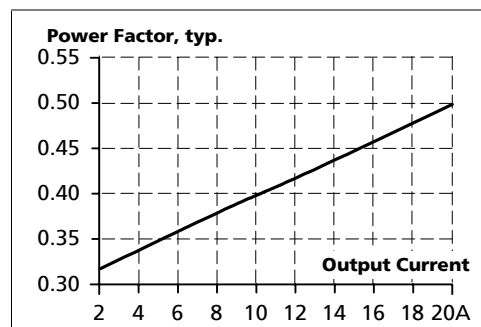

Fig. 5-4 **Power factor vs. output load at 230Vac**



6. INPUT INRUSH CURRENT

An active inrush current circuitry (NTC and fixed resistor which are bypassed by an IGBT after the inrush is completed) limits the input inrush current after turn-on of the input voltage.

The charging current into EMI suppression capacitors is disregarded in the first millisecond after switch-on.

Input: 230Vac

Inrush current	max.	52A _{peak}	+40°C ambient temperature, cold start
	typ.	40A _{peak}	+40°C ambient temperature, cold start
Inrush energy	max.	4A ² s	+40°C ambient temperature, cold start

Fig. 6-1 **Input inrush current, typical behavior**

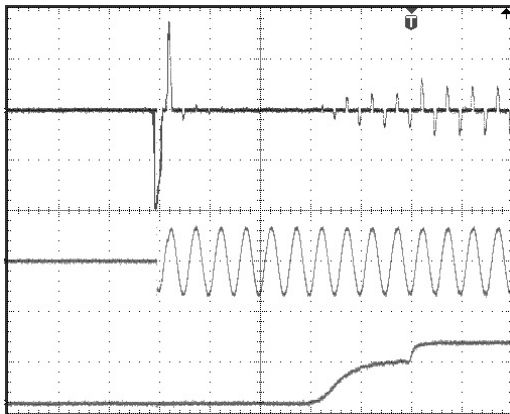

Input: 230Vac
 Output: 24V, 20A
 Ambient: 40°C, cold start
 Upper curve: Input current 20A / DIV
 Medium curve: Input voltage 500V / DIV
 Lower curve: Output voltage 20V / DIV
 Time basis: 40ms / DIV

7. OUTPUT

Output voltage	nom.	24V	
Adjustment range	min.	24-28V	guaranteed, multi turn potentiometer
	max.	30V	at clockwise end position of potentiometer
Factory setting		24.1V	±0.2%, at full load, cold unit
Line regulation	max.	10mV	170 to 300Vac
Load regulation	max.	100mV	static value, 0A → 20A → 0A
Ripple and noise voltage	max.	100mVpp	20Hz to 20MHz, 50Ohm
Output capacitance	typ.	8 500µF	

Continuous power capability

Output current	nom.	20A	at 24V, see Fig. 7-1
	nom.	17A	at 28V, see Fig. 7-1
Output power	nom.	480W	24V, continuous
	nom.	480W	28V, continuous
Short-circuit current	min.	30A	Load impedance 50mOhm, for typ. 2s before hiccup mode starts, see Fig. 7-1 and Fig. 7-3
	max.	40A	

BonusPower®, short term power capability (up to typ. 4s)

The power supply is designed to support loads with a higher short-term power requirement without damage or shutdown. The short-term duration is hardware controlled by an output power manager. This BonusPower® is repeatedly available. Detailed information can be found in chapter 26.1. If the power supply is loaded longer with the BonusPower® than shown in the Bonus-time diagram (see Fig. 7-2), the max. output power is automatically reduced to 480W.

If the power requirement is continuously above 480W and the voltage falls below approx. 20V (due to the current regulating mode at overload), the unit shuts-off and makes periodical restart attempts. This behavior is called hiccup mode which is described below. If the voltage is above 20V, the unit continuously delivers current.

Hiccup Mode:

Up to 4s of overloading, the power supply delivers continuous output current. After this, the output power is reduced to nearly zero for approx. 17s before a new start attempt is automatically performed. If the overload has been cleared, the device will operate normally. If the overload still exists, the output current will be delivered for 2 to 4s (depending on the overload) again followed by a 17 s rest time. This cycle is repeated as long as the overload exists. See Fig. 7-3. During the off-period a small rest voltage and rest current is present on the output.

Output current	nom.	30A	at 24V, see Fig. 7-1 and Fig. 7-2
	nom.	26A	at 28V, see Fig. 7-1 and Fig. 7-2
Output power	nom.	720W	24V, short term
	nom.	720W	28V, short term
Short-circuit current	min.	30A	Load impedance 50mOhm, for typ. 2s before hiccup mode starts, see Fig. 7-1 and Fig. 7-3
	max.	40A	
Bonus time	typ.	4s	at 24V, 30A, duration until the output voltage dips, see Fig. 7-2
	min.	3.5s	
	max.	4.5s	

Fig. 7-1 **Output voltage vs. output current, typ.**

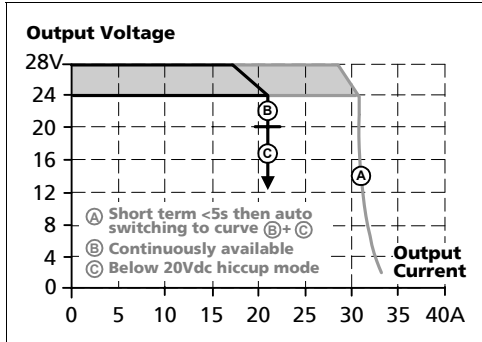

Fig. 7-2 **Bonus time vs. output power**

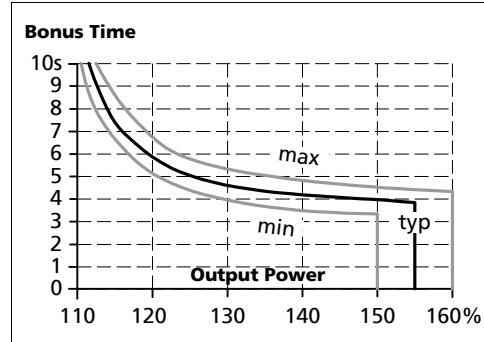
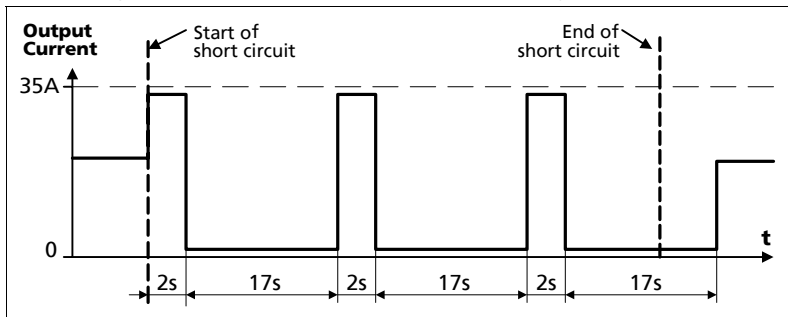

Fig. 7-3 **Short-circuit on output, hiccup mode, typical behavior**



The Bonus Power® is available as soon as power comes on and immediately after the end of an output short circuit or output overload.

Fig. 7-4 **BonusPower® after input turn-on**

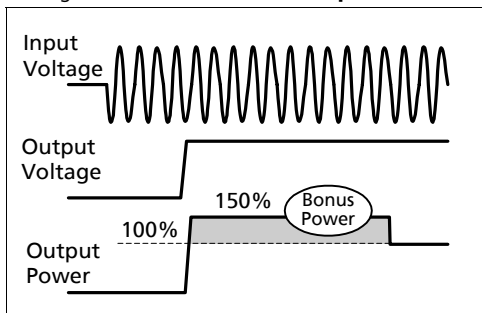
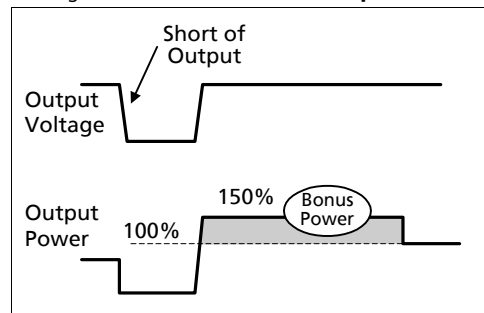

Fig. 7-5 **BonusPower® after output short**



Peak current capability (up to several ms)

The power supply can deliver a peak current which is higher than the specified short term current. This helps to start current demanding loads or to safely operate subsequent circuit breakers.

The extra current is supplied by the output capacitors inside the power supply. During this event, the capacitors will be discharged and causes a voltage dip on the output. Detailed curves can be found in chapter 26.2.

Peak current voltage dips	typ.	from 24V to 19V	at 40A for 20ms
	typ.	from 24V to 18V	at 80A for 2ms
	typ.	from 24V to 17.5V	at 80A for 5ms

8. HOLD-UP TIME

Input: 230Vac

Hold-up Time	typ.	46ms	20A, 24V, see Fig. 8-1
	typ.	94ms	10A, 24V, see Fig. 8-1

Fig. 8-1 Hold-up time vs. input voltage

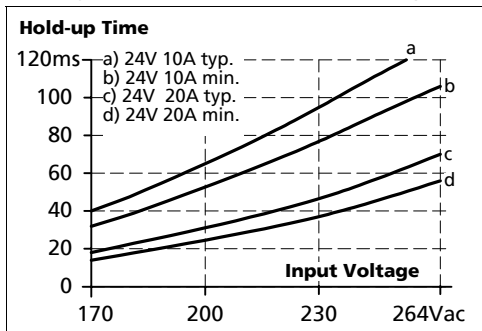
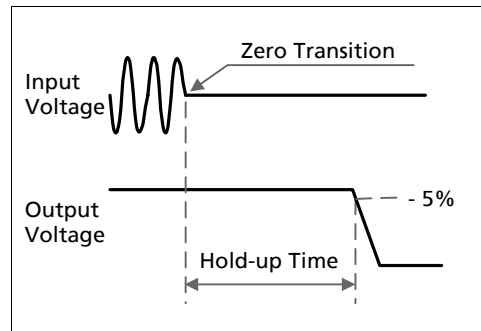

Fig. 8-2 Shut-down behavior, definitions



9. DC-OK RELAY CONTACT

This feature monitors the output voltage, which is produced by the power supply itself. It is independent of a backed voltage from a unit which is connected in parallel to the power supply output.

Contact closes	As soon as the output voltage reaches the adjusted output voltage.		
Contact opens	As soon as the output voltage dips more than 10% below the adjusted output voltage. Short dips will be extended to a signal length of 250ms. Dips shorter than 1ms will be ignored.		
Contact re-closes	As soon as the output voltage exceeds 90% of the adjusted voltage.		
Contact ratings	max	60Vdc 0.3A, 30Vdc 1A, 30Vac 0.5A	resistive load
	min	1mA at 5Vdc	min. permissible load
Isolation voltage	See dielectric strength table in section 19		

Fig. 9-1 DC-ok relay contact behavior

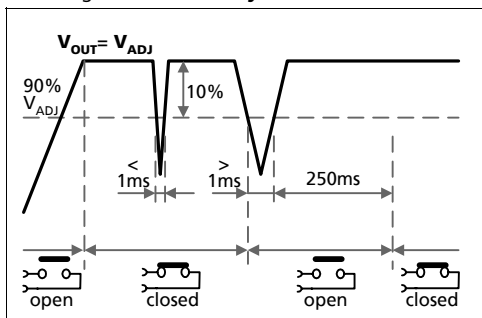

Note:

The DC-ok feature requires that the output voltage reaches the nominal (=adjusted) level after turn-on in order to function according to specification. If this level cannot be achieved, the overload LED will be on and the DC-ok contact will be open. The overload signal will only shut off as soon as the adjusted voltage is reached. This is an important condition to consider particularly, if the load is a battery, the power supply is used in parallel or the power supply is used for N+1 redundant systems.

10. EFFICIENCY AND POWER LOSSES

Input: 230Vac

Efficiency	typ.	94.5%	20A, 24V
Power losses	typ.	28.3W	20A, 24V
	typ.	4.4W	0A

Fig. 10-1 Efficiency vs. output current at 24V output voltage and 230Vac input voltage

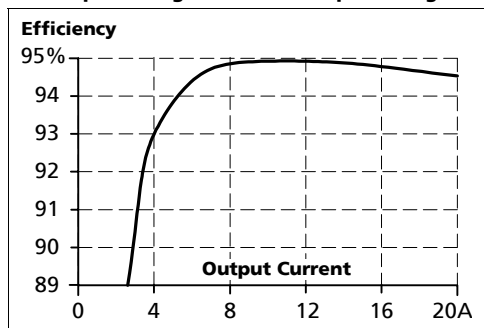

Fig. 10-2 Losses vs. output current at 24V output voltage and 230Vac input voltage

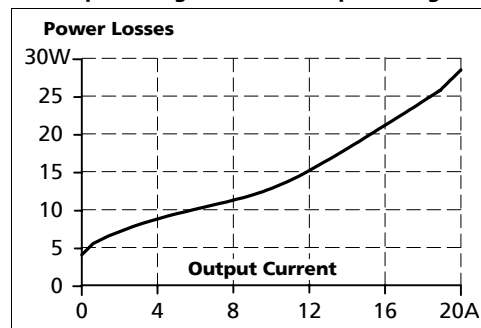

Fig. 10-3 Efficiency vs. input voltage, 24V, 20A

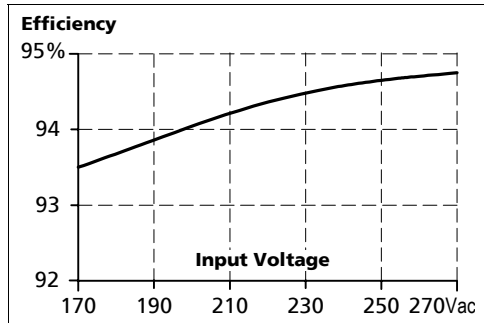
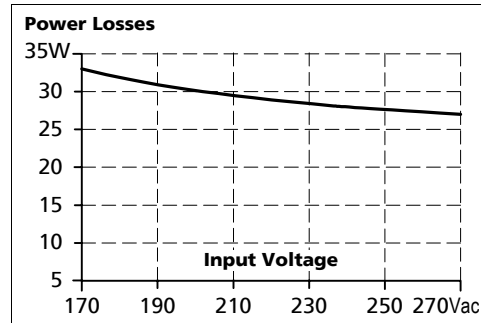
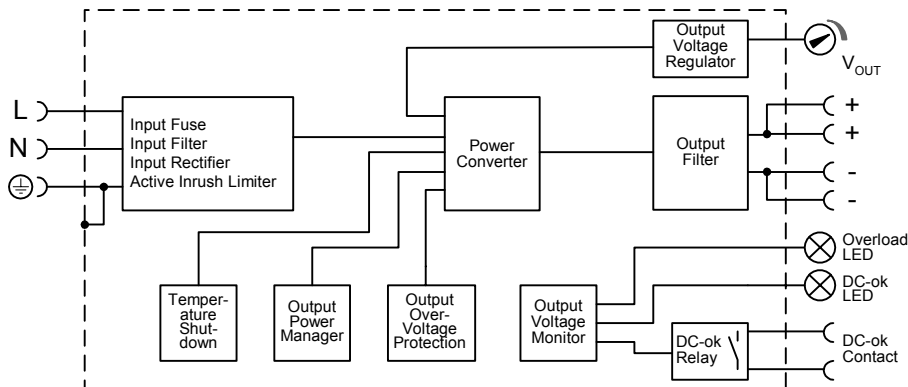

Fig. 10-4 Losses vs. input voltage, 24V, 20A



11. FUNCTIONAL DIAGRAM

Fig. 11-1 Functional diagram



12. FRONT SIDE AND USER ELEMENTS

Fig. 12-1 Front side

Output Terminals

Quick-connect spring-clamp terminals, no tools required
 + Positive output pole
 - Negative output pole
 Dual pins per pole

DC ok Relay contact (NO-contact)

480W Continuous power / 720W Peak power

Input Terminals

Quick-connect spring-clamp terminals, no tools required
 N ... Neutral input
 L ... Line (hot) input
 PE ... PE (Protective Earth)
 See chapter 13 "Terminals and Wiring" to choose appropriate wire gauges

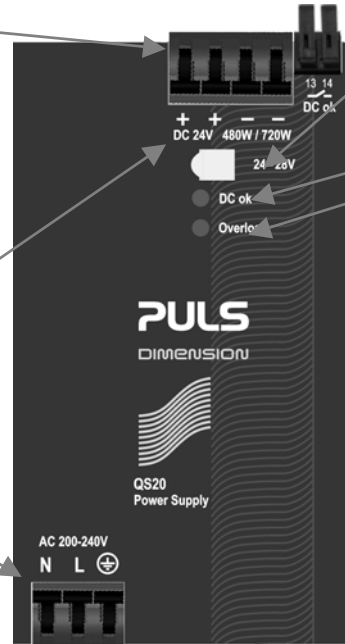

Output voltage potentiometer

(multi turn potentiometer)
 Open the flap to tune the output voltage.
 Factory setting: 24.1V

DC-ok LED (green)
Overload LED (red)

	Overload LED	DC-ok LED	DC-ok contact
Normal mode	OFF	ON	Closed
BonusPower® mode	OFF	ON	Closed
Overload ($V_{OUT} > 90\%$)	OFF	ON	Closed
Overload ($V_{OUT} < 90\%$)	*)	OFF	Open
Short-circuit ($V_{OUT} = ca. 0V$)	*)	OFF	Open
Over-temperature	*)	OFF	Open
No input power	OFF	OFF	Open

DC-ok LED and DC-ok contact function synchronized

*) Up to 4s of overloading, the power supply delivers continuous output current. After this, the output power is reduced to nearly zero for approx. 17s before a new start attempt is automatically performed. If the overload has been cleared, the device will operate normally. If the overload still exists, the output current will be delivered for 2 to 4s (depending on the overload) again followed by a 17s rest time. This cycle is repeated as long as the overload exists. The red overload LED is permanently on when the overload current is continuously flowing. During the 17s rest period, the red LED is flashing with a frequency of approx. 1.3Hz.

13. TERMINALS AND WIRING

Type	Bi-stable, quick-connect spring clamp terminals. IP20 Finger safe construction. Suitable for field- and factory installation. Shipped in open position.
Ferrules	allowed, but not required
Pull-out force	10AWG:80N, 12AWG:60N, 14AWG:50N, 16AWG:40N (according to UL486E)

	Power terminals	DC-OK-Signal terminals
Solid wire	0.5-6mm ²	0.3-4mm ²
Stranded wire	0.5-4mm ²	0.3-2.5mm ²
American wire gauge	20-10 AWG	26-12 AWG
Wire stripping length	10mm / 0.4inch	6mm / 0.25inch

Fig. 13-1 Connecting a wire

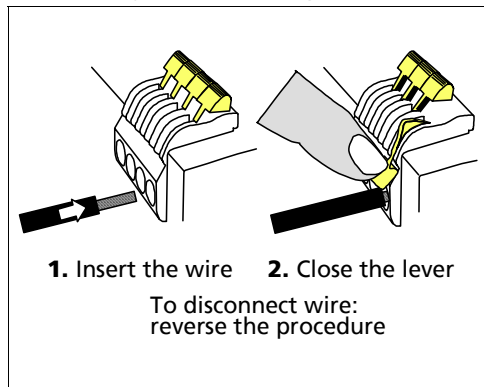

Instructions:

- a) Use appropriate copper cables that are designed for an operating temperature of: 60°C for ambient up to 45°C and 75°C for ambient up to 60°C minimum.
- b) Follow national installation codes and installation regulations!
- c) Ensure that all strands of a stranded wire enter the terminal connection!
- d) Up to two stranded wires with the same cross section are permitted in one connection point (except PE wire).
- e) Do not use the unit without PE connection.

14. RELIABILITY

	Input: 230Vac		
Lifetime expectancy	min.	62 000h	40°C, 24V, 20A
	min.	15 years	40°C, 24V, 10A
	min.	188 000h	25°C, 24V, 20A
MTBF SN 29500, IEC 61709		577 000h	40°C, 24V, 20A
		946 000h	25°C, 24V, 20A
MTBF MIL HDBK 217F		305 000h	40°C, 24V, 20A, Ground Benign GB40
		409 000h	25°C, 24V, 20A, Ground Benign GB25

The **Lifetime expectancy** shown in the table indicates the operating hours (service life) and is determined by the lifetime expectancy of the built-in electrolytic capacitors.

Lifetime expectancy is specified in operational hours. Lifetime expectancy is calculated according to the capacitor's manufacturer specification. The prediction model allows a calculation of up to 15 years from date of shipment.

MTBF stands for **Mean Time Between Failure**, which is calculated according to statistical device failures, and indicates reliability of a device. It is the statistical representation of the likelihood of the unit to fail and does not necessarily represent the life of a product.

June. 2008 / Rev. 1.1 DS-QS20.244-EN
 All parameters are specified at 24V, 20A, 230Vac, 25°C ambient and after a 5 minutes run-in time unless otherwise noted.

15. EMC

The CE mark indicates conformance with EMC directive 89/336/EC, 93/68/EC and 2004/108/EC and the low-voltage directive (LVD) 73/23/EC, 93/68/EC, 2006/95/EC. A detailed EMC report is available on request.

EMC Immunity	EN 61000-6-1 EN 61000-6-2		Generic standards	
Electrostatic discharge	EN 61000-4-2	Contact discharge	8kV	Criterion A
		Air discharge	15kV	Criterion A
Electromagnetic RF field	EN 61000-4-3	80MHz-2.7GHz	10V/m	Criterion A
Fast transients (Burst)	EN 61000-4-4	Input lines	4kV	Criterion A
		Output lines	2kV	Criterion A
Surge voltage on input	EN 61000-4-5	L → N	2kV	Criterion A
		N / L → PE	4kV	Criterion A
Surge voltage on output	EN 61000-4-5	+ → -	500V	Criterion A
		+ / - → PE	500V	Criterion A
Conducted disturbance	EN 61000-4-6	0.15-80MHz	10V	Criterion A
Mains voltage dips	EN 61000-4-11	0% of 200Vac	0Vac, 20ms	Criterion A
		40% of 200Vac	80Vac, 200ms	Criterion C
		70% of 200Vac	140Vac, 500ms	Criterion A
Voltage interruptions	EN 61000-4-11		0Vac, 5000ms	Criterion C
Input voltage swells	PULS internal standard		300Vac, 500ms	Criterion A
Powerful transients	VDE 0160	over entire load range	750V, 1.3ms	Criterion A

Criteria:

A: Power supply shows normal operation behavior within the defined limits.

C: Temporary loss of function is possible. Power supply might shut-down and restarts by itself. No damages or hazards for the power supply occur.

EMC Emission	Generic standards: EN 61000-6-4	
Conducted emission	EN 55011, EN 55022, FCC Part 15, CISPR 11, CISPR 22	Class B, input lines
	EN 55022	Class B, output lines
Radiated emission	EN 55011, EN 55022	Class B
Harmonic input current	EN 61000-3-2	Not fulfilled
Voltage fluctuations, flicker	EN 61000-3-3	Fulfilled

This device complies with FCC Part 15 rules.

Operation is subjected to following two conditions: (1) this device may not cause harmful interference, and (2) this device must accept any interference received, including interference that may cause undesired operation.

The power supply does not fulfill the harmonic current standard EN61000-3-2. Please note:

A power supply has to comply with EN 61000-3-2 (Standard for harmonic input current) when:

- 1) the end-device is used within the European Union **and**
- 2) the end-device is connected to a public mains supply with a nominal voltage $\geq 220\text{Vac}$ **and**
- 3) the power supply is:
 - fitted in an end-device with an average input power in excess of 75W **or**
 - fitted in an end-device with a continuous input power in excess of 75W **or**
 - part of a lighting system.

Exceptions:

End-devices for professional applications with an input power > 1000W do not need to fulfill EN 61000-3-2.

Comments:

- The average input power must be determined in accordance with EN 61000-3-2.
- Industrial mains supplies with their own transformer are considered to be "non-public".
- Where individual self-contained items of equipment are installed in a rack or case (e.g. devices connected in parallel), they are regarded as being individually connected to the mains supply. The rack or case need not be tested as a whole. Alternatively it is also permitted to assess the whole rack or case. This is recommended for devices used in professional applications with an input power greater than 1000W.

Switching Frequencies	The power supply has three converters with three different switching frequencies included. One is nearly constant. The others are input voltage and load dependent.	
Switching frequency 1	100kHz	Resonant converter, nearly constant
Switching frequency 2	125kHz to 510kHz	Boost converter, input voltage and load dependent
Switching frequency 3	35-45kHz	Aux. Converter, input voltage and load dependent

16. ENVIRONMENT

Operational temperature	-25°C to +70°C (-13°F to 158°F)	reduce output power above +60°C
Output de-rating	12W/°C	60-70°C (140°F to 158°F), see Fig. 16-1
Storage temperature	-40 to +85°C (-40°F to 185°F)	storage and transportation
Humidity	5 to 95% r.H.	IEC 60068-2-30 Do not energize while condensation is present
Vibration sinusoidal	2-17.8Hz: ±1.6mm; 17.8-500Hz: 2g, 2 hours / axis	IEC 60068-2-6
Vibration random	0.5m ² (s ³), 2 hours / axis	IEC 60068-2-64
Shock	30g 6ms, 20g 11ms 3 bumps / direction, 18 bumps in total	IEC 60068-2-27
Altitude	0 to 6000m (0 to 20 000ft)	Reduce output power or ambient temperature above 2000m sea level.
Output de-rating (for altitude)	30W/1000m or 5°C/1000m	above 2000m (6500ft), see Fig. 16-2
Over-voltage category	III II	EN 50178, altitudes up to 2000m Altitudes from 2000m to 6000m
Degree of pollution	2	EN 50178, not conductive

Fig. 16-1 Output current vs. ambient temp.,

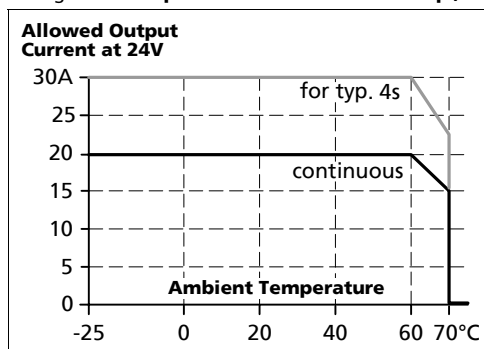
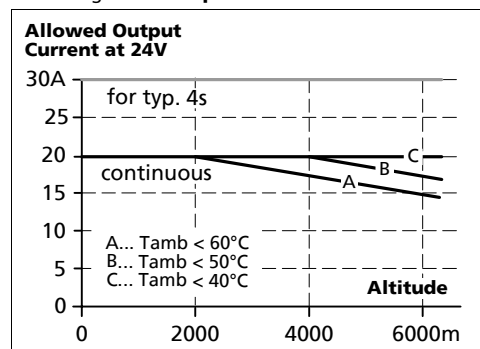

Fig. 16-2 Output current vs. altitude



The ambient temperature is defined as the air temperature 2cm below the unit.

17. PROTECTION FEATURES

Output protection	Electronically protected against overload, no-load and short-circuits	
Output over-voltage protection	typ. 32Vdc max. 37Vdc	In case of an internal power supply defect, a redundant circuitry limits the maximum output voltage. The output shuts down and automatically attempts to restart.
Output over-current protection	Electronically limited	See Fig. 7-1
Degree of protection	IP 20	EN/IEC 60529
Penetration protection	> 3.5mm / >5mm	top side / bottom side, e.g. screws, small parts
Over-temperature protection	yes	output shut-down with automatic restart
Input transient protection	MOV (Metal Oxide Varistor)	
Internal input fuse	T10A H.B.C.	not user replaceable

Note: In case of a protection event, audible noise may occur.

18. SAFETY

Input / output separation	SELV PELV double or reinforced insulation	IEC/EN 60950-1 EN 60204-1, EN 50178, IEC 60364-4-41
Class of protection	I	PE (Protective Earth) connection required
Isolation resistance	> 5MΩ	input to output, 500Vdc
PE resistance	< 0.1Ω	between housing and PE terminal
Touch current (leakage current)	typ. 0.55mA < 0.87mA	230Vac, 50Hz, TN mains 264Vac, 50Hz, TN mains

19. DIELECTRIC STRENGTH

Fig. 19-1 Dielectric strength

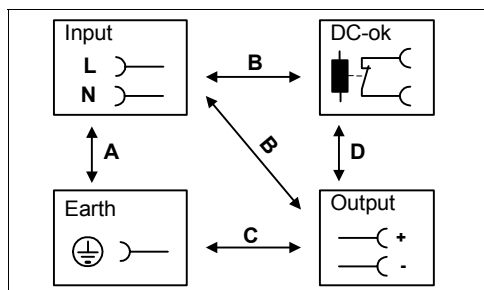

		A	B	C	D
Type test	60s	2500Vac	3000Vac	500Vac	500Vac
Factory test	5s	2500Vac	2500Vac	500Vac	500Vac
Field test	5s	2000Vac	2000Vac	500Vac	500Vac

Type tests and factory tests:

Conducted by the manufacturer. Do not repeat test in field!





Rules for field test:

Use appropriate test equipment which applies the voltage with a slow ramp! Connect L and N together as well as all output poles.

The output voltage is floating and has no ohmic connection to ground.

To fulfill the PELV requirements according to EN60204-1 § 6.4.1, we recommend that either the + pole, the - pole or any other part of the output circuit shall be connected to the protective earth system. This helps to avoid situations in which a load starts unexpectedly or can not be switched off any more when unnoticed earth faults occur.

20. APPROVALS

IEC 60950-1		CB Scheme, Information Technology Equipment
UL 508		LISTED E198865 Industrial Control Equipment
UL 60950-1		RECOGNIZED E137006 recognized for the use in U.S.A. (UL 60950-1) and Canada (C22.2 No. 60950) Information Technology Equipment, Level 5
CSA		CSA approval for Canada CAN/CSA C22.2 No 107-1; CAN/ CSA 60950-1-03; UL60950-1
Marine		GL (Germanischer Lloyd) classified and ABS (American Bureau for Shipping) PDA for marine and offshore applications. Environmental category: C, EMC2

21. FULFILLED STANDARDS

EN 61558-2-17	Safety of Power Transformers
EN/IEC 60204-1	Safety of Electrical Equipment of Machines
EN/IEC 61131-2	Programmable Controllers
EN 50178, IEC 62103	Electronic Equipment in Power Installations

22. USED SUBSTANCES

The unit does not release any silicone and is suitable for the use in paint shops.

The unit conforms to the RoHS directive 2002/96/EC

Electrolytic capacitors included in this unit do not use electrolytes such as Quaternary Ammonium Salt Systems.

Plastic housings and other molded plastic materials are free of halogens.

The production material within our production does not include following toxic chemicals:

Polychlorized Biphenyl (PCB), Polychlorized Terphenyl (PCT), Pentachlorophenol (PCP), Polychlorinated naphthalene (PCN), Polybrom Biphenyl (PBB), Polybrom Biphenyl-oxyd (PBO), Polybrominated Diphenylether (PBDE), Polychlorinated Diphenylether (PCDE), Polydibromphenyl Oxyd (PBDO), Cadmium, Asbest, Mercury, Silicia

23. PHYSICAL DIMENSIONS AND WEIGHT

Weight 880g / 1.94lb

DIN-Rail Use 35mm DIN-rails according to EN 60715 or EN 50022 with a height of 7.5 or 15mm. The DIN-rail height must be added to the depth (127mm) to calculate the total required installation depth.

Electronic files with mechanical data can be downloaded at www.pulspower.com

Fig. 23-1 Front view

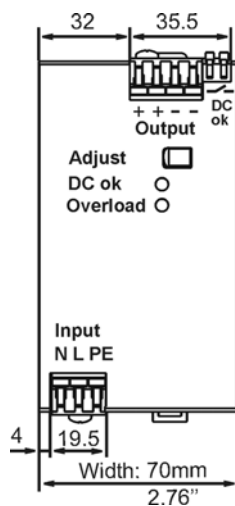
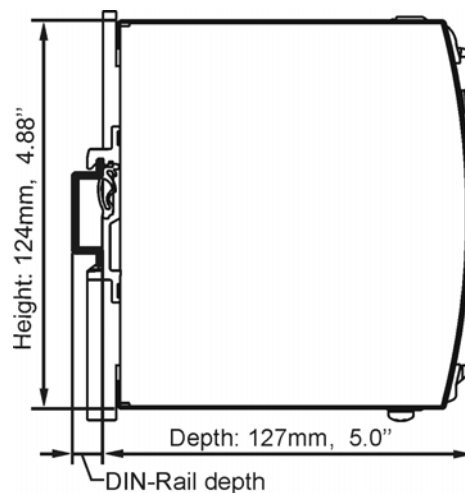

Fig. 23-2 Side view



24. INSTALLATION AND OPERATION INSTRUCTIONS

Mounting and installation:

Output terminal must be located on top and input terminal on the bottom. For other orientations see section 26.14. An appropriate electrical and fire end-product enclosure needs to be considered in the end use application.

Cooling:

Convection cooled, no forced cooling required. Do not cover ventilation grid (e.g. cable conduits) by more than 30%!

Installation clearances:

40mm on top, 20mm on the bottom, 5mm on the left and right side are recommended when loaded permanently with full power. In case the adjacent device is a heat source, 15mm clearance is recommended.

Risk of electrical shock, fire, personal injury or death!

Do not use the unit without proper earth connection (Protective Earth). Use the pin on the terminal block for earth connection and not one of the screws on the housing.

Turn power off before working on the power supply. Protect against inadvertent re-powering.

Make sure the wiring is correct by following all local and national codes.

Do not open, modify or repair the unit.

Use caution to prevent any foreign objects from entering into the housing.

Do not use in wet locations or in areas where moisture or condensation can be expected.

Service parts:

The unit does not contain any serviceable parts. The tripping of an internal fuse is caused by an internal defect. If damage or malfunctioning should occur during operation, immediately turn power off and send unit to factory for inspection!

25. ACCESSORY

ZM1.WALL Wall mounting bracket

This bracket is used to mount Dimension units onto a flat surface without utilizing a DIN-Rail. The two aluminum brackets and the black plastic slider of the unit have to be detached, so that the two steel brackets can be mounted.

Fig. 25-1 ZM1.WALL Wall Mounting Bracket

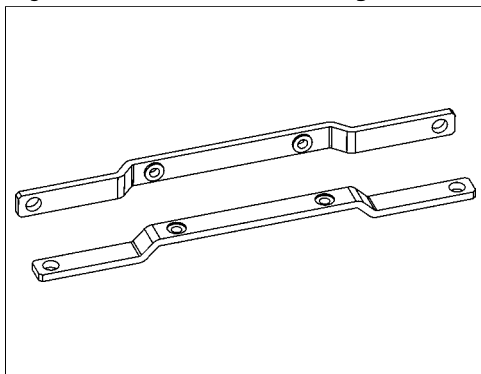
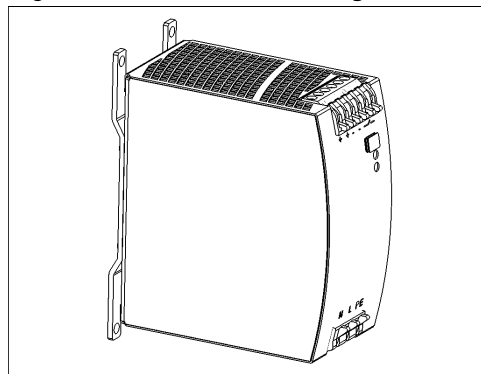

Fig. 25-2 Assembled Wall Mounting Bracket



Please note: Symbolic drawing, picture show a different model

26. APPLICATION NOTES

26.1. REPETITIVE PULSE LOADING

Typically, a load current is not constant. It varies over time. For pulse load compatibility, following rules must be met:

- The pulse power demand must be below 150% of the nominal power.
- The duration of the pulse power must be shorter than the allowed Bonus Time. (see output section)
- The average (R.M.S.) output current must be below the specified continuous output current.
If the R.M.S. current is higher, the unit will respond with a thermal shut-down after a while. Use the max. duty cycle curve (Fig. 26-2) to check if the average output current is below the nominal current.
- For altitudes higher than 2000m reduce the pulse loading (30W/1000m) or the ambient temperature (5°C/1000m)

Fig. 26-1 Repetitive pulse loads, definitions

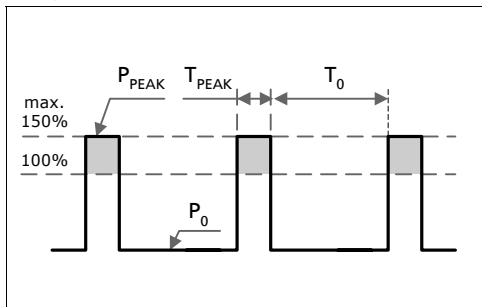

- P_0** Base load (W)
- P_{PEAK}** Pulse load (above 100%)
- T_0** Duration between pulses (s)
- T_{PEAK}** Pulse duration (s)

Fig. 26-2 Max. Duty Cycle Curve

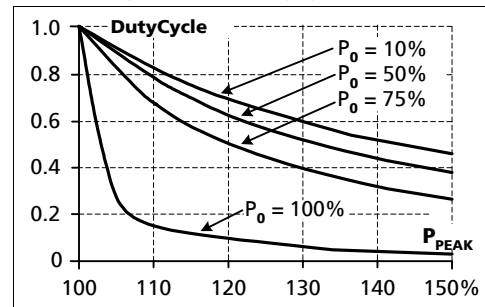

$$\text{DutyCycle} = \frac{T_{peak}}{T_{peak} + T_0}$$

$$T_0 = \frac{T_{peak} - (\text{DutyCycle} \times T_{peak})}{\text{DutyCycle}}$$

Utilizing the Max. Duty Cycle Curve:

Example to determine the repetition rate of pulses without dipping of the output voltage:

Parameters of application:

Pulse length is $T_{PEAK} = 1s$

Steady state load $P_0=120W$
(= 50% of I_{RATED})

Peak load $P_{PEAK} = 360W$
(= 150% of I_{RATED})

Determining the repetition rate:

- make a vertical line at $P_{PEAK} = 150\%$
- make a horizontal line where the vertical line crosses the $P_0 = 50\%$ curve
- Read the Max. Duty Cycle from the Duty Cycle-axis (= 0.37)
- Calculate the min. pause (base load) length T_0 :

$$T_0 = \frac{T_{peak} - (\text{DutyCycle} \times T_{peak})}{\text{DutyCycle}} = \frac{1s - (0.37 \times 1s)}{0.37} = \underline{1.7s}$$

- Pulse length = 1s, min. pause length = 1.7s
- Max. repetition rate = pulse length + pause length = **2.7s**

More examples for pulse load compatibility:

P_{PEAK}	P_0	T_{PEAK}	T_0
720W	480W	1s	>25s
720W	0W	1s	>1.3s
600W	240W	1s	> 0.75s

P_{PEAK}	P_0	T_{PEAK}	T_0
720W	240W	0.1s	>0.16s
720W	240W	1s	>1.6s
720W	240W	3s	>4.9s

26.2. PEAK CURRENT CAPABILITY

Solenoids, contactors and pneumatic modules often have a steady state coil and a pick-up coil. The inrush current demand of the pick-up coil is several times higher than the steady state current and usually exceeds the nominal output current (including the Bonus Power®). The same situation applies, when starting a capacitive load.

Branch circuits are often protected with circuit breakers or fuses. In case of a short or an overload in the branch circuit, the fuse needs a certain amount of over-current to trip or to blow. The peak current capability ensures the safe operation of subsequent circuit breakers.

Assuming the input voltage is turned on before such an event, the built-in large sized output capacitors inside the power supply can deliver extra current. Discharging this capacitor causes a voltage dip on the output. The following two examples show typical voltage dips:

Fig. 26-3 **Peak load 40A for 50ms, typ.**

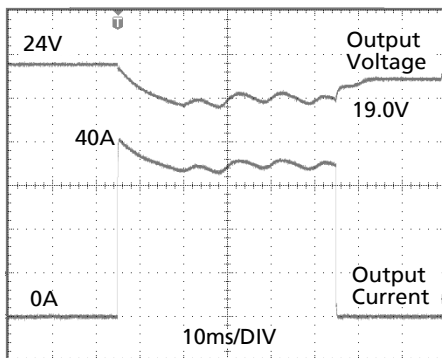

Peak load 40A (resistive) for 50ms
Output voltage dips from 24V to 19.0V.

Fig. 26-4 **Peak load 80A for 5ms, typ.**

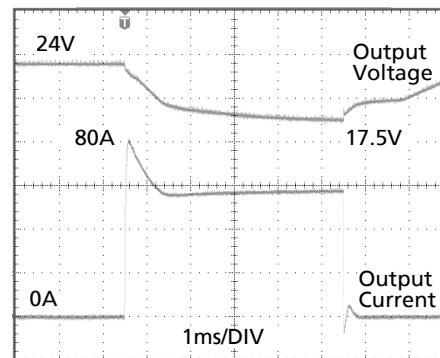

Peak load 80A (nearly resistive) for 5ms
Output voltage dips from 24V to 17.5V.

Please note: The DC-OK relay triggers when the voltage dips more than 10% for longer than 1ms.

26.3. BACK-FEEDING LOADS

Loads such as decelerating motors and inductors can feed voltage back to the power supply. This feature is also called return voltage immunity or resistance against Back- E.M.F. (Electro Magnetic Force).

This power supply is resistant and does not show malfunctioning when a load feeds back voltage to the power supply. It does not matter, whether the power supply is on or off.

The maximum allowed feed back voltage is 34Vdc. The absorbing energy can be calculated according to the built-in large sized output capacitor which is specified in chapter 7. If the feed back voltage gets higher than 34Vdc, the power supply responds with a shut-down and a subsequent start-up attempt.

26.4. CHARGING OF BATTERIES

The power supply can be used for float-charging of lead-acid or maintenance free 24V VRLA batteries.

Instructions for charging batteries:

- a) Set the output voltage, at disconnected load, very precisely to the end-of-charge voltage according to the expected battery temperature.

End-of-charge voltage	27.8V	27.5V	27.15V	26.8V
Battery temperature	10°C	20°C	30°C	40°C

- b) Use a 25A circuit breaker (or blocking diode) between the power supply and the battery.
- c) Ensure that the output current of the power supply is below the allowed charging current of the battery.
- d) Use only matched batteries when putting 12V types in series.
- e) The return current to the power supply is typ. 9mA at 25Vdc when the power supply is switched off.

26.5. OUTPUT CIRCUIT BREAKERS

Standard miniature circuit breakers (MCBs) can be used for branch protection. Ensure that the MCB is rated for DC voltage, too. The following tests show which circuit breakers the power supply typically trips.

Circuit breakers have huge tolerances in their tripping behavior. Therefore, these typical tests can only be used as a recommendation or for comparing two different power supplies. Furthermore, the loop impedance has a major influence on whether a breaker trips or not. Two tests were performed, representing typical situations:

Test 1: Short circuit with S1 on the power supply end of the cable (loop impedance approx. 20mOhm)

Fig. 26-5 **Branch protectors, test circuit 1**

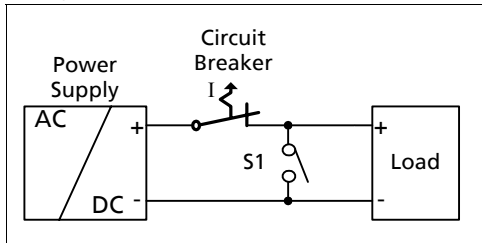

Parameters:

Input voltage: 230Vac, load current: 0A
Tripping time shorter than 5s.

The following circuit breaker tripped during the test:

- A- or Z- Characteristic:** equal or smaller 25A *)
- B- Characteristic:** equal or smaller 20A *)
- C- Characteristic:** equal or smaller 13A *)

Test 2: Short circuit with S1 on the load end (additional impedance included; represents longer load wire length).

Fig. 26-6 **Branch protectors, test circuit 2**

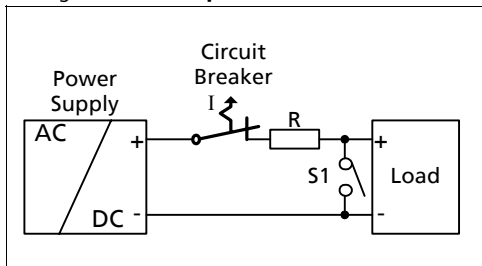

Parameters:

Input voltage: 230Vac, load current: 0A
Tripping time shorter than 5s.

The following circuit breaker tripped during the test:

- A- or Z- Characteristic:** ≤ 20A and R < 82mOhm *)
- B- Characteristic:** ≤ 13A and R < 120mOhm *)
- C- Characteristic:** ≤ 8A and R < 150mOhm *)

What does this resistance mean in wire length?

	0.5mm ²	0.7mm ²	1.0mm ²	1.5mm ²	2.5mm ²	4.0mm ²
82mOhm	2.3m	3.2m	4.6m	6.9m	11.4m	18.3m
120mOhm	3.3m	4.7m	6.7m	10.0m	16.7m	26.7m
150mOhm	4.2m	5.9m	8.4m	12.5m	20.9m	33.4m

*) A list of the circuit breakers under test is available on request.

Example:

Which wire gauge must be used to trip a C-Characteristic circuit breaker with a rating of 8A? The load wire length is 19m.

Answer: A 8A C-Characteristic circuit breaker requires a loop impedance of less than 150mOhm (test results). The wire length table shows that up to 20.9m wire with a cross section of 2.5mm² are below 150mOhm. A wire not smaller than 2.5mm² shall be used.

26.6. EXTERNAL INPUT PROTECTION

The unit is tested and approved for branch circuits up to 20A. External protection is only required, if the supplying branch has an ampacity greater than this. In some countries local regulations might apply. Check also local codes and local requirements.

If an external fuse is necessary or utilized, a minimum value is required to avoid undesired tripping of the fuse.

		B-Characteristic	C-Characteristic
Ampacity	max.	20A	20A
	min.	10A	6A

26.7. PARALLEL USE TO INCREASE OUTPUT POWER

Power supplies can be paralleled to increase the output power.

Fig. 26-7 Schematic for parallel operation

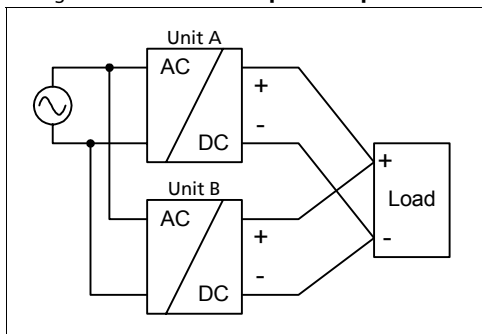

Instructions for parallel use:

- Use only power supplies from the same series (Q-Series).
- Adjust the output voltages of all power supplies to approximately the same value ($\pm 500\text{mV}$). Otherwise, the DC-ok signal might not work properly.
- A fuse (or diode) on the output is only required if more than three units are connected in parallel.
- Do not continuously load the terminals with more than 25A. Follow wiring instructions according to chapter 26.9
- Keep an installation clearance of 15mm (left/right) between two power supplies and avoid installing the power supplies on top of each other.

26.8. PARALLEL USE FOR REDUNDANCY

Power supplies can be paralleled for redundancy to gain a higher system availability. Redundant systems require a certain amount of extra power to support the load in case one power supply unit fails. The simplest way is to put two Q-Series power supplies in parallel. This is called a 1+1 redundancy. In case one power supply unit fails, the other one is automatically able to support the load current without any interruption. Redundant systems for a higher power demand are usually built in a N+1 method. E.g. Five power supplies, each rated for 10A are paralleled to build a 40A redundant system.

Please note: This simple way to build a redundant system does not cover failures such as an internal short circuit in the secondary side of the power supply. In such a - virtually nearly impossible - case, the defect unit becomes a load for the other power supplies and the output voltage can not be maintained any more. This can only be avoided by utilizing decoupling diodes which are included in the decoupling module YR2.DIODE. (One Diode module per power supply)

Recommendations for building redundant power systems:

- Use separate input fuses for each power supply.
- Monitor the individual power supply units. A DC-ok LED and a DC-ok contact is already included in the units. This feature reports a faulty unit.
- When possible, connect each power supply to different phases or circuits.
- It is desirable to set the output voltages of all power supplies to the same value to avoid a false DC-ok signal.

26.9. DAISY-CHAINING OF OUTPUTS

Daisy chaining (jumping from one power supply output to the next) is allowed as long as the max. current through one terminal pin does not continuously exceed 20A. If the current is higher, use a separate distribution terminal.

Fig. 26-8 **Daisy chaining of outputs**

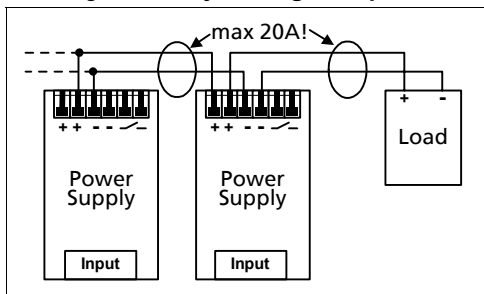
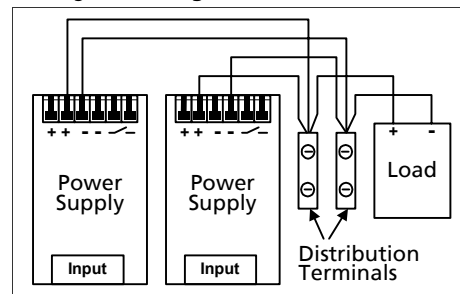

Fig. 26-9 **Using distribution terminals**



26.10. SERIES OPERATION

The power supply can be put in series to increase the output voltage.

Fig. 26-10 **Schematic for series operation**

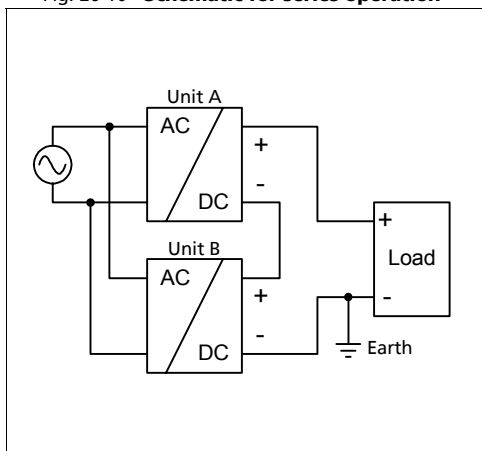

Instructions for use in series:

- It is possible to connect as many units in series as needed, providing the sum of the output voltage does not exceed 150Vdc.
- Voltages with a potential above 60Vdc are not SELV any more and can be dangerous. Such voltages must be installed with a protection against touching.
- For serial operation use power supplies of the same type.
- Earthing of the output is required when the sum of the output voltage is above 60Vdc.
- Keep an installation clearance of 15mm (left/right) between two power supplies and avoid installing the power supplies on top of each other.

Note: Avoid return voltage (e.g. from a decelerating motor or battery) which is applied to the output terminals.

26.11. INDUCTIVE AND CAPACITIVE LOADS

The unit is designed to supply any kind of load, including unlimited capacitive and inductive loads.

26.12. OPERATION ON TWO PHASES

Fig. 26-11 Schematic for two phase operation

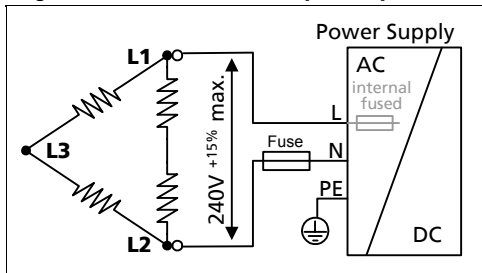

Instructions for two phase operation:

- A phase to phase connection is allowed as long as the supplying voltage is below $240V^{+15\%}$.
- Use a fuse or a circuit breaker to protect the N input. The N input is internally not protected and is in this case connected to a hot wire.

Appropriate fuses or circuit breakers are specified in section 26.6 "External Input Protection".

26.13. USE IN A TIGHTLY SEALED ENCLOSURE

When the power supply is installed in a tightly sealed enclosure, the temperature inside the enclosure will be higher than outside. The inside temperature defines the ambient temperature for the power supply.

Results from such an installation:

Power supply is placed in the middle of the box, no other heat producer inside the box

Enclosure:	Rittal Type IP66 Box PK 9522 100, plastic, 254x180x165mm
Load:	24V, 16A; (=80%) load is placed outside the box
Input:	230Vac
Temperature inside enclosure:	48.2°C (in the middle of the right side of the power supply with a distance of 2cm)
Temperature outside enclosure:	24.7°C
Temperature rise:	23.5K

26.14. MOUNTING ORIENTATIONS

Mounting orientations other than input terminals on the bottom and output on the top require a reduction in continuous output power or a limitation in the max. allowed ambient temperature. The amount of reduction influences the lifetime expectancy of the power supply. Therefore, two different derating curves for continuous operation can be found below:

Curve A1 Recommended output current.

Curve A2 Max allowed output current (results approx. in half the lifetime expectancy of A1).

Fig. 26-12
Mounting Orientation A
Standard Orientation

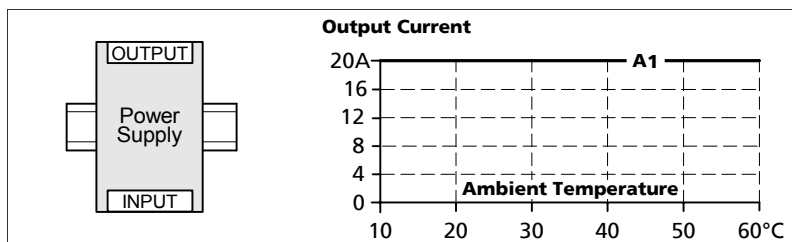

Fig. 26-13
Mounting Orientation B
(Upside down)

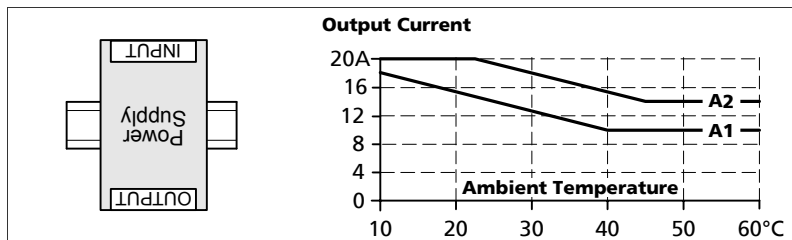

Fig. 26-14
Mounting Orientation C
(Table-top mounting)

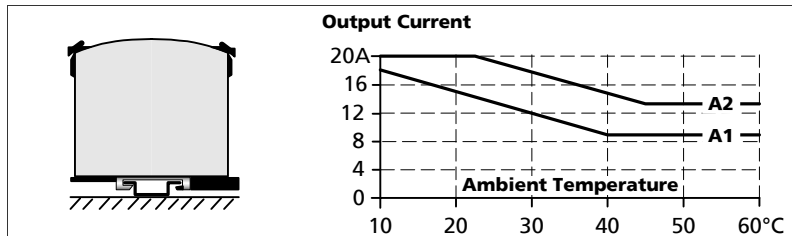

Fig. 26-15
Mounting Orientation D
(Horizontal cw)

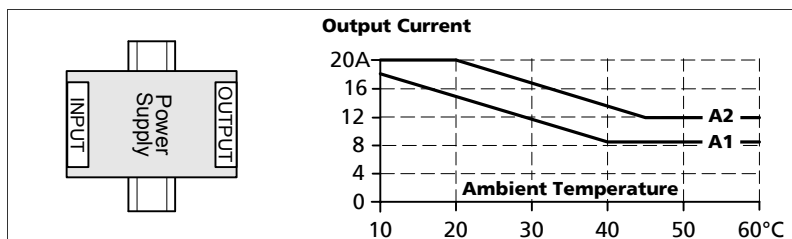

Fig. 26-16
Mounting Orientation E
(Horizontal ccw)

